

FILL-RITE®

FR1118-A10 User's Manual



 **WARNING**

Read carefully and understand all INSTRUCTIONS before operating.

Failure to follow the safety rules and other basic safety precautions may result in serious personal injury. Save these instructions in a safe place and on hand so that they can be read when required.

1. INTRODUCTION

1.1 Technical Data

1.1.1 The turbine digital meter is designed for use with the following low viscosity fluids:

- diesel fuel
- kerosene

WARNING! Use of other fluids may be inaccurate and can damage the meter!

1.1.2 Flow Rate: 3-26GPM, flow rates outside of this range may have reduced accuracy.

1.1.3 Operating pressure: 10BAR / 145PSI

1.1.4 Inlet/Outlet: 1"

IMPORTANT! Not suitable for retail sale of diesel, oil, or kerosene!

1.2 LCD DISPLAY

The meter display features two numerical registers and several function or status indicators.

#	Description
1	Resettable Register (5 digit, from 0.1-99999).
2	Battery condition.
3	"Calibration" mode.
4	Resetting current total to 0.
5	Totalizer Register (total cumulative fluid dispensed).
6	Rate of flow being displayed.
7	Unit of measure (liters, gallons, quarts, pints).

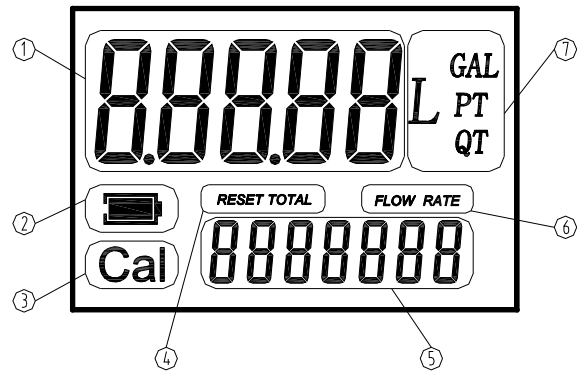

Fig. 1

1.3 USER BUTTONS

The face of the turbine digital meter has two buttons (MENU and RESET) which individually perform two main functions and together, other secondary functions.

The main functions performed are:

For the reset key, resetting the partial Register and reset table total (reset total)

For the menu key, entering instrument calibration mode.

Used together, the two keys permit entering configuration mode.

1.4 BATTERY REPLACEMENT

The battery in your in-line digital meter is not replaceable. To minimize the possibility of fire or explosion, it is a sealed unit that does not allow for user replacement. Do not attempt to open or replace the battery in your meter.

2. INSTALLATION

The inlet and outlet for this meter is 1"BSP/NPT. It can be easily connected with the pipe or nozzle.

3. DAILY USE

3.1 BUTTON USAGE, CALIBRATION AND MEASUREMENT UNIT CHANGE

- **Reset the present total (See Fig. 2)**

- 1) When the meter is in standby mode, press the RESET key.
- 2) The display shows all the segments at once.
- 3) The meter resets to display "0" on the resettable totalizer.

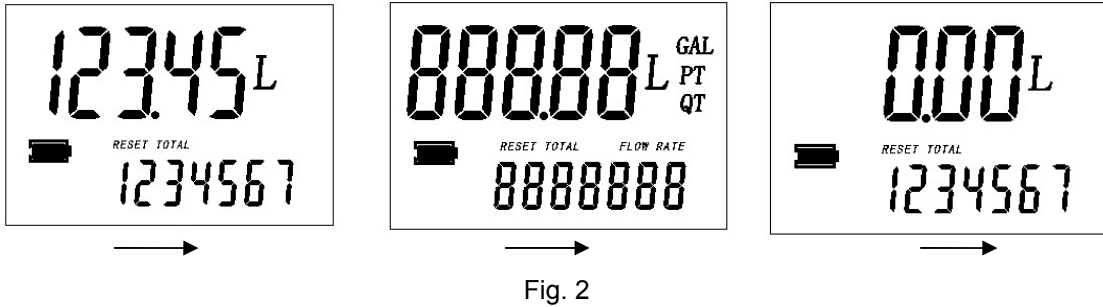

- **Show current correction factor and general total (See Fig. 3)**

Press MENU and RESET together and hold for two seconds.

Value "1.4000" is the correction factor which can be reset;
"1234567" is the general total which cannot be reset.

Fig. 3



- **Measurement unit change (See Fig. 4)**

Press MENU and RESET together and hold for five seconds.

Zone 7 on the display is the current unit. Press RESET to choose a different measurement unit and then press MENU to confirm.

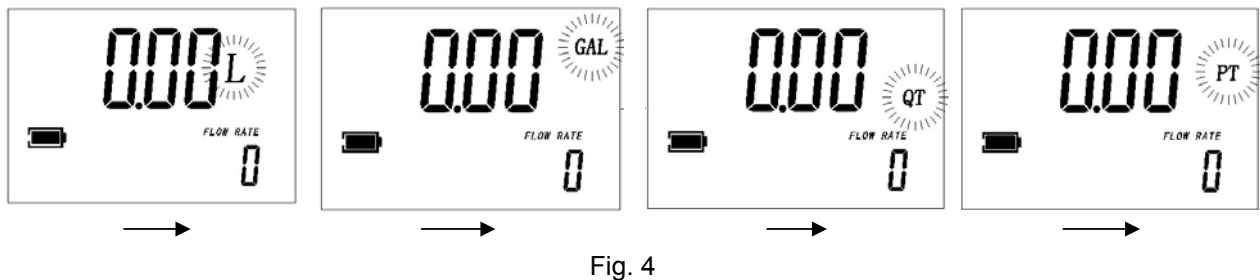

3.2 RESET THE RESETTABLE TOTALIZER (SEE FIG. 5)

When the meter is in standby, press the RESET key for 2 seconds to reset the totalizer.

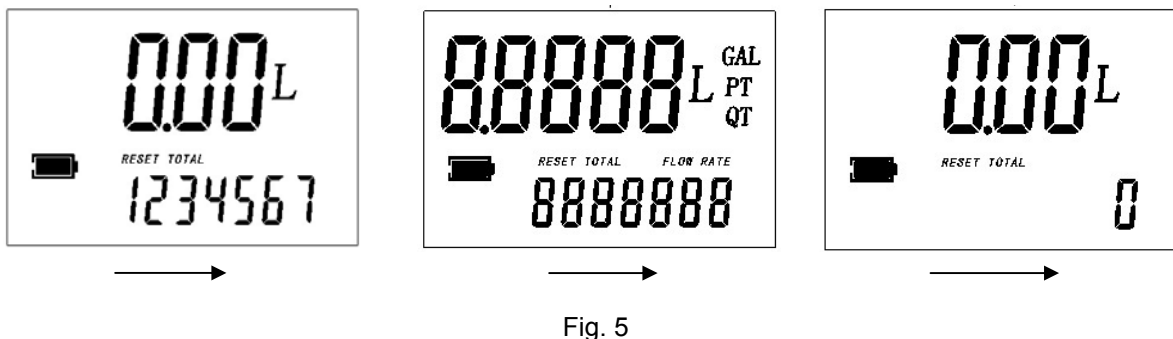

3.3 Calibration Procedure (Using the Correction Factor)





Carefully follow the procedure indicated below.

FORMULA

Proper correction factor = current correction factor × (actual value / display value)







Example:

Actual value **20.75**
Display value **18.96**
Current correction factor **1.000**
Proper correction factor **1.000 × (20.75 / 18.96) = 1.000 × 1.094 = 1.094**

1	Wait for the meter to go into standby (blank screen).	
2	With the meter in stand-by mode, reset the resettable total by pressing the “RESET” button.	
3	Press and hold the MENU key until the first digit in the display begins to flash (approximately 5 seconds). The meter is in calibration mode.	
4	Press the RESET key to choose the right digit from 0 to 9. Press the MENU key to start the next digit. So the digit of correction factor can be changed one by one.	
5	Make sure the correction factor is right, press the MENU key. Keep it pressed until quit calibration mode, the factor is saved. The meter goes to standby again.	

3.4 MODIFY THE CORRECTION FACTOR IN FIELD

PLEASE CAREFULLY FOLLOW THE PROCEDURE INDICATED BELOW.

1	Wait for the meter to go to standby.	
2	Reset the resettable total.	
3	<p>Start dispensing into a measuring glass.</p>  <p>Stop dispensing when 5 Litres of volume is reached, read out the actual value. The volume that is displayed on the LCD is the Display Value, not the Actual Value which may be slightly higher. For example, in the figure on the right, the Display Value is 18.96 while the Actual Value is 20.75.</p>	 
4	<p>Press the MENU key. Keep it pressed until showed as the right fig., the digit flash in ① zone, Press the RESET key to choose the right digit from 0 to 9. Press the MENU key to go the the next digit so that the Actual Value can be input.</p>	
5	<p>Make sure the correction factor is right and then press the MENU key. Keep it pressed until calibration is finished and the factor is saved. The meter will then return to standby.</p>	

4. MALFUNCTIONS

Problem	Possible Cause	Corrective Action
LCD: no indication	Bad battery contact	Check battery contacts
Imprecise measurement	Wrong FACTOR	With reference to paragraph 3.3 & 3.4, check the FACTOR
	The meter works below minimum acceptable flow rate	Increase the flow rate until an acceptable flow rate range has been achieved
Reduced or zero flow rate	Turbine blocked	Clean the turbine.
The meter does not count, but the flow rate is correct	Incorrect installation of gears after cleaning	Repeat the reassembly process.
	Possible electronic card problems	Contact Northern Tool + Equipment

5. DIAGRAM AND PARTS LIST

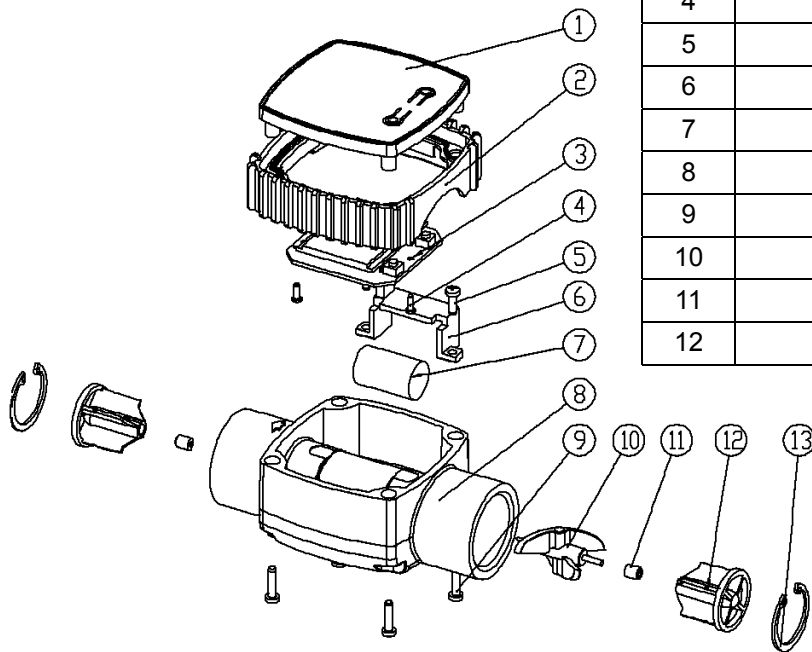

No	Description	Qty.
1	Meter Cover	1
2	Rubber Protection	1
3	Self-tap screw	2
4	Battery Holder	1
5	Electric Board	1
6	Battery CR2	1
7	Self-tap	3
8	Meter body	1
9	Bearing	2
10	Self-tap screw	4
11	Turbine	1
12	Bearing Holder	1